

KIARA

PELLET AIR



Vista superiore



Serbatoio e display



Maniglia "mano fredda"



Angoli arrondati

KIARA











PELLET AIR



KIARA

Classe energetica	A+	
Conformità	EN 14785: 10-2006	
Dimensioni	L 47 x P 55 x H 97 cm	
Dimensioni collo	0,52 m ³	
Peso stufa	Kg 80	
Potenza termica introdotta	kW 8,9	
Potenza termica nominale	kW 8,2	
Potenza termica ridotta	kW 2,5	
Rendimento potenza %	min 93,3 %	max 91,7 %
Emissioni di CO (al 13% di O2)	min 122 mg/Nm ³	max 54 mg/Nm ³
Emissioni CO (13% O2)	min 0,010 Vol.-%	max 0,004 Vol.-%
Emissioni OGC (13% O2)	min 1 mg/Nm ³	max 1 mg/Nm ³
Emissioni NOx (13% O2)	min 172 mg/Nm ³	max 158 mg/Nm ³
Contenuto medio polveri (13% O2)	14 mg/Nm ³	
Tiraggio minimo camino	min 10 Pa	max 12 Pa
Diametro scarico fumi	Ø 80 mm	
Diametro condotto aspirazione	Ø 40 mm	
Capacità serbatoio	Kg 22	
Consumo pellet	min 0,54 kg / h	max 1,83 kg / h
Tensione alimentazione	V/HZ 230 / 50	
Assorbimento elettrico nominale	max 78 W	
Assorbimento elettrico in accensione	345 W	
M ³ riscaldabili	55 / 182 m ³	
Rumorosità dB	dB 37 / 46	
Combustibile	PELLET EN PLUS A1	

PLUS

-  Stufa Ermetica
-  Braciere INOX 316
-  Uscita fumi posteriore
-  Sistema di modulazione
-  Silenziosa
-  Programmazione giornaliera / settimanale
-  5 regolazioni di potenza
-  Display 5 lingue integrate
-  Mano fredda
-  Vetro ceramico

OPTIONAL

-  Wi-Fi
-  Telecomando



Prodotto conforme alla Classe 4 Stelle secondo i requisiti di emissioni e rendimento del Decreto 7 Novembre 2017, n. 186



Prodotto equivalente alle 7 stelle Flamme Verte

COMPATIBILE CON
amazon alexa



KIARA

PELLET AIR

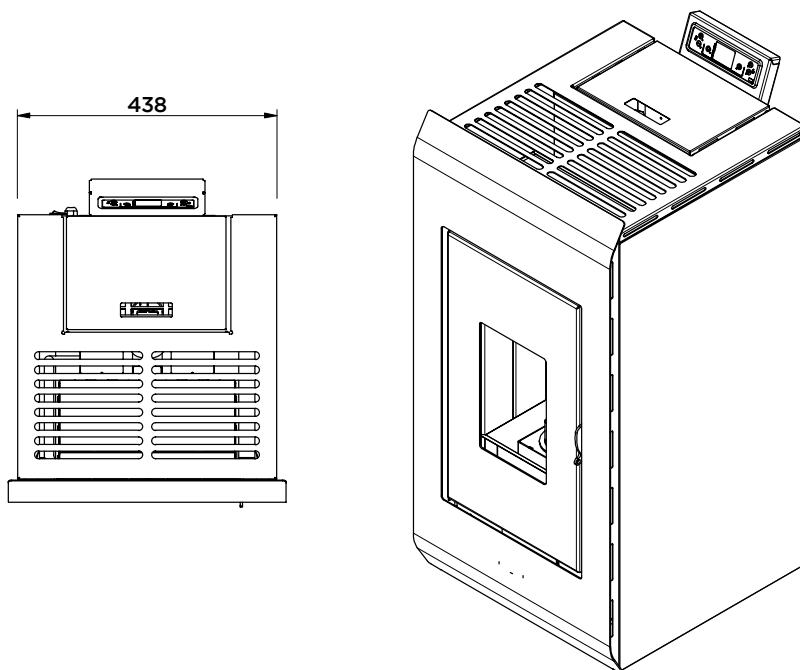
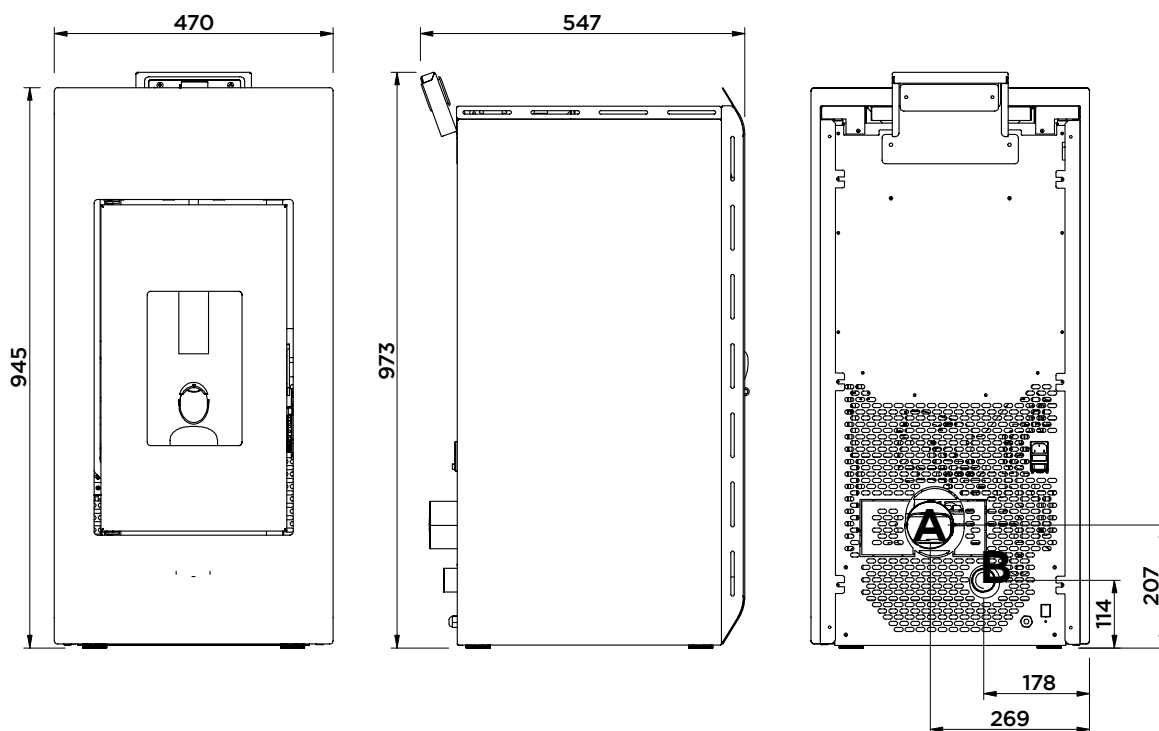

KIARA	
Scarico fumi	A
Entrata aria comburente	B
Uscita Canalizzazione	-
Canalizzabile sino a metri lineari	